

Article number: 12704000060800

Description: KLEE-coil 704 000 060.800
M6 Brass

Measures

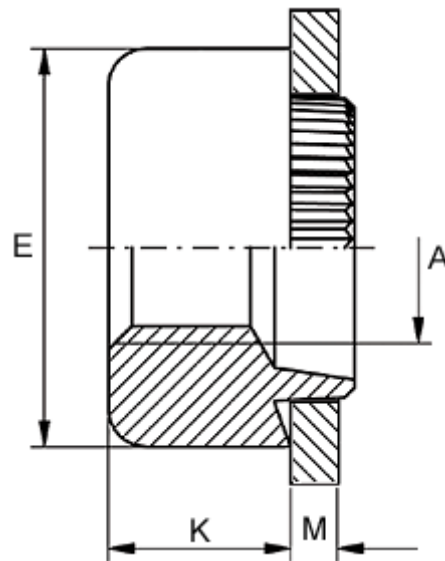

Female thread A	= M6
Height K	= 6.0
Outer diameter E	= 13.0
Plate thickness	= 0.9 to 1.0
Recommended bore diameter for extreme load	= 10.0
Recommended bore diameter for normal use	= 10.0